

EE-SPX303/403

Large Slot Width (13 mm) Not Influenced by External Light

- Easy adjustment and optical axis monitoring with a Light-ON indicator
- Wide operating voltage range (12 to 24 VDC) makes smooth connection possible with TTLs, relays, and programmable controllers (PLC)
- Convert to PNP output with EE-2002 conversion connector
- EE-SPX303-1 model is available for applications that require a 5 VDC input

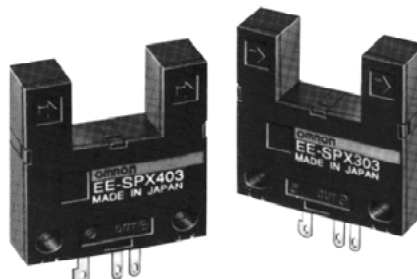

Ordering Information

Appearance	Sensing method	Slot width	Slot depth	Output configuration	Weight	Part number
	Slot	13 mm	10 mm	Dark-ON	Approx. 3.0 g	EE-SPX303
				Dark-ON, 5 VDC		EE-SPX303-1
				Light-ON		EE-SPX403

■ ACCESSORIES

Name	Part number
Solder connector	EE-1001
Connector with 2 m cable	EE-1006

Specifications

■ RATINGS

Item		EE-SPX303	EE-SPX303-1	EE-SPX403
Supply voltage		12 to 24 VDC $\pm 10\%$, ripple (p-p): 5% max.	5VDC $\pm 10\%$, ripple (p-p): 5% max.	12 to 24 VDC $\pm 10\%$, ripple (p-p): 5% max.
Current consumption		Average: 15 mA max.; Peak: 50 mA max.		
Slot width		13 mm		
Standard reference object		Opaque: 0.5 x 1 mm ² min.		
Differential distance		0.05 mm max.		
Control output		At 5 to 24 VDC: 80 mA load current (I_C) with a residual voltage of 1.0 V max. When driving TTL: 10 mA load current (I_C) with a residual voltage of 0.4 V max.		
Output configuration	Transistor on output stage without detecting object	OFF		ON
	Transistor on output stage with detecting object	ON		OFF
Indicator (See note 1.)	Without detecting object	ON		
	With detecting object	OFF		
Response frequency (See note 2.)		500 Hz		
Light source		GaAs infrared LED (pulse-modulated) with a peak wavelength of 940 nm		
Receiver		Si photo-diode with a sensing wavelength of 850 nm max.		
Connecting method		Connector EE-1001/1006; solder terminals/cordset		

- Note: 1. The indicator is a GaP red LED (peak emission wavelength: 700 nm).
 2. The response frequency was measured by detecting the following disks rotating.

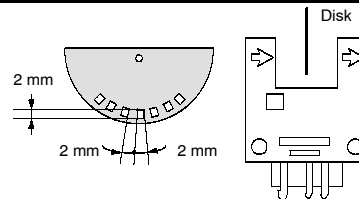

■ CHARACTERISTICS

Ambient illumination		Sensing face: fluorescent light/incandescent light: 3,000 ℓ x max.
Enclosure ratings		IP50
Ambient temperature	Operating	-10° to 55°C (14°F to 131°F)
	Storage	-25° to 65°C (-13°F to 149°F)
Ambient humidity	Operating	35% to 85%
Vibration resistance		Destruction: 10 to 55 Hz, 1.5-mm double amplitude for 2 hrs each in X, Y, and Z directions
Shock resistance		Destruction: 500 m/s ² (approx. 50G) for 3 times each in X, Y, and Z directions
Cable length		5 m max. (AWG24 min.)

Engineering Data

SENSING POSITION CHARACTERISTICS (EE-SPX303)

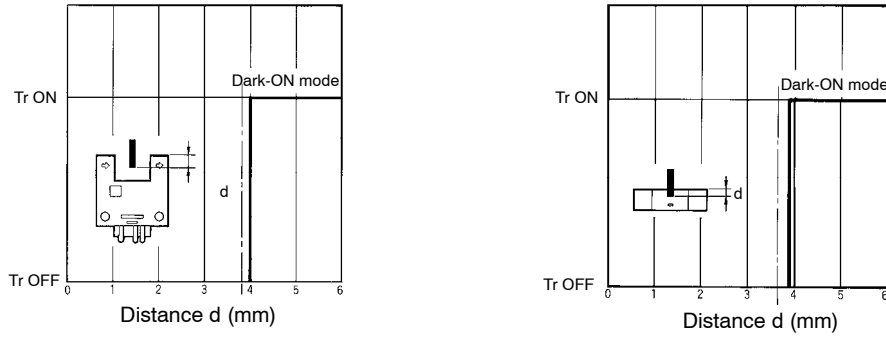

Note: The sensing position characteristics of the EE-SPX403 are opposite those of the EE-SPX303.

Operation

INTERNAL/EXTERNAL CIRCUIT DIAGRAM

Light-ON/Dark-ON

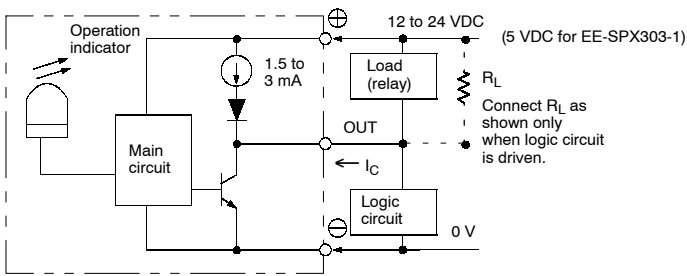

Connect a diode in parallel to the load when an inductive load is connected between + and OUT.

TIMING CHART

Light-ON

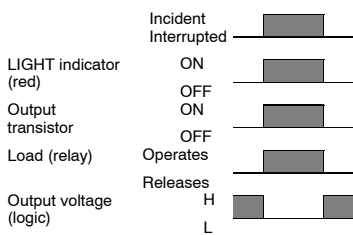

Dark-ON

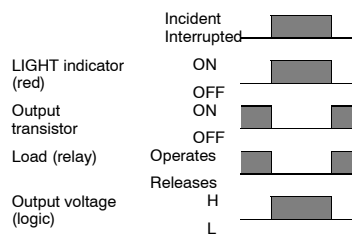

Dimensions

Unit: mm (inch)

EE-SPX303, EE-SPX303-1, EE-SPX403

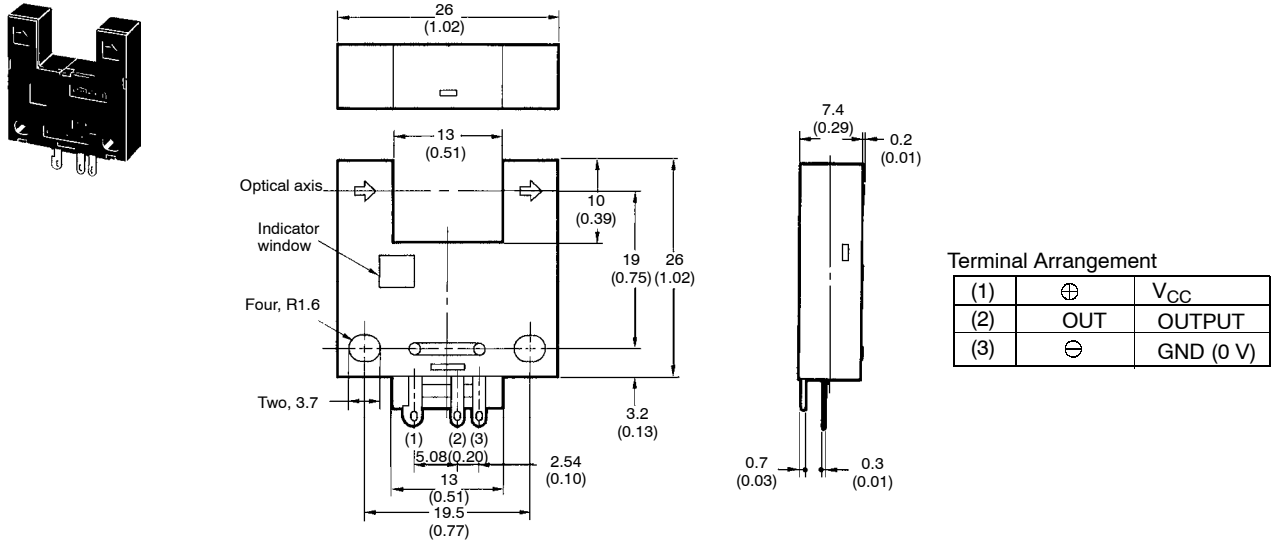

EE-1001 SOLDER CONNECTOR

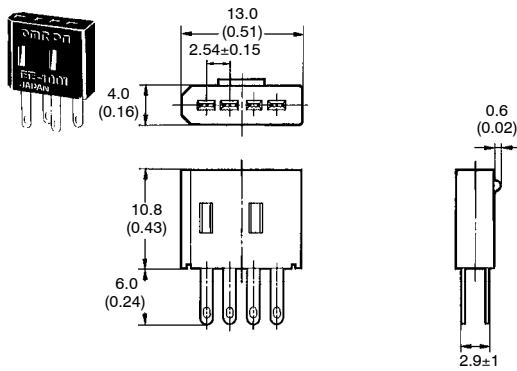

EE-SPX303 (403) + EE-1001

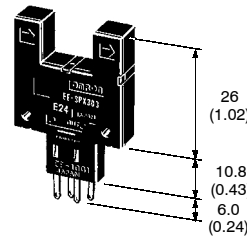

EE-1006 CONNECTOR

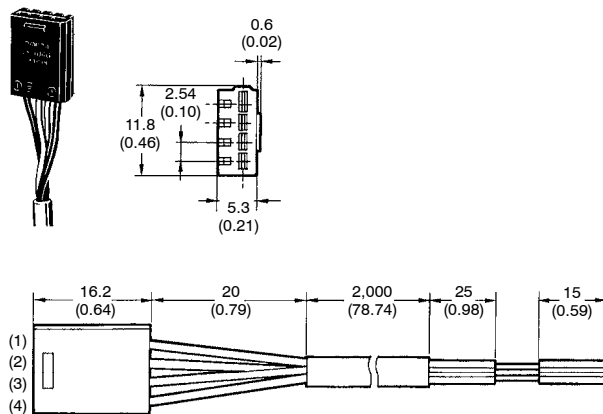

EE-SPX303 (403) + EE-1006

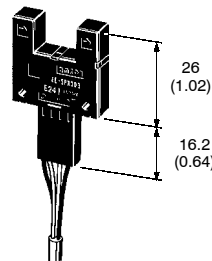

Terminal Arrangement

(1)	Red (Brown)	⊕	V _{CC}
(2)	Yellow (Pink)	L	L
(3)	White (Black)	OUT	OUTPUT
(4)	Black (Blue)	⊖	GND (0 V)

IEC colors are shown in parentheses.

Precautions

Refer the Technical Information Section for general precautions.

■ WIRING

A cable with a thickness of AWG24 min. and a length of 5 m max. must be connected to the output terminals.

To use a cable longer than 5 m, attach a capacitor with a capacitance of approximately 10 μF to the wires, as shown below. The distance between the terminal and the capacitor must be within 5 m:

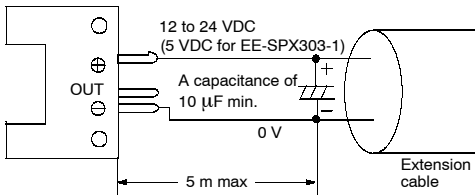

Do not impose excessive force on the terminals (refer to the diagram below). Excess force will damage the terminals.

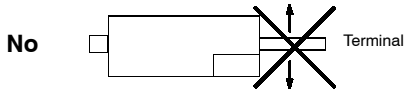

Do not disconnect the EE-1001 or EE-1006 Connector from the photomicrosensor when power is supplied to the photomicrosensor, or sensor damage could result.

If the metal mounting base is subjected to inductive electrical noise, the photomicrosensor can be activated accidentally. If noise is a problem, take the following precautions:

1. Connect the GND terminal to the mounting base, so there will be no difference in electric potential between the photomicrosensor and mounting base.

2. Connect the negative terminal to the mounting base via a 0.47- μF capacitor.
3. Insert a plastic insulating plate with a thickness of approximately 10 mm between the photomicrosensor and mounting base.

Wire, as shown by the following illustration, to connect a small inductive load (a relay for example) to the photomicrosensor. A diode must be connected parallel to the relay to absorb the reverse voltage.

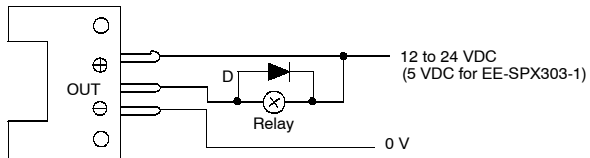

■ POWER SUPPLY

When using a standard switching regulator, ground the FG and G terminal so that the photomicrosensor will be in a stable operating condition.

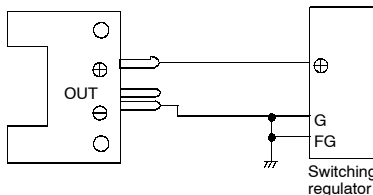

NOTE: DIMENSIONS SHOWN ARE IN MILLIMETERS. To convert millimeters to inches divide by 25.4.

OMRON®

OMRON ELECTRONICS LLC

One East Commerce Drive
Schaumburg, IL 60173

1-800-55-OMRON

OMRON ON-LINE

Global - <http://www.omron.com>

USA - <http://www.omron.com/oei>

Canada - <http://www.omron.com/oci>

OMRON CANADA, INC.

885 Milner Avenue
Toronto, Ontario M1B 5V8

416-286-6465